

COVER LABELING

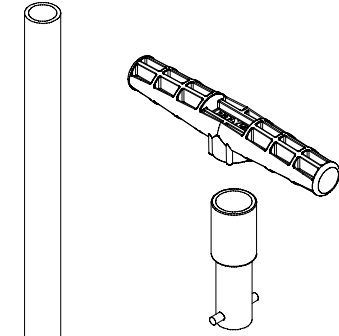

POLYLOK SUPPLIED
18 3/4" x 3/4" PVC PIPE

OPTIONAL
POLYLOK PRESSURE FILTER WRENCH KIT
PART NO. 3014-PFW

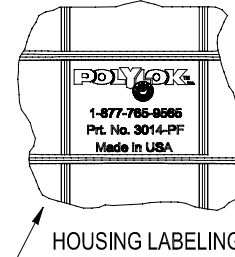
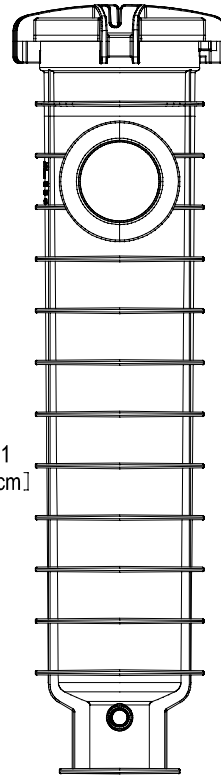
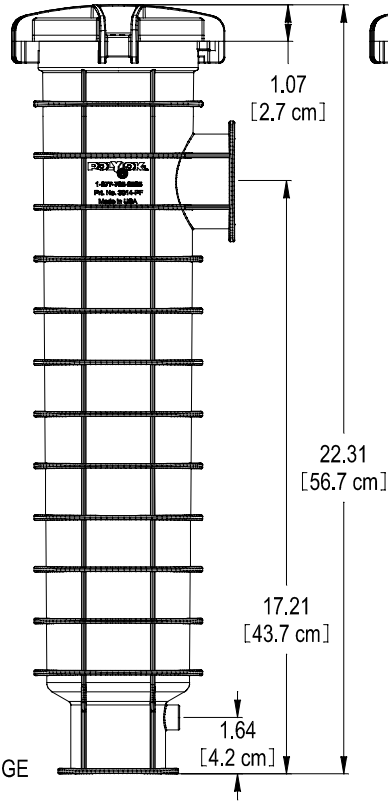
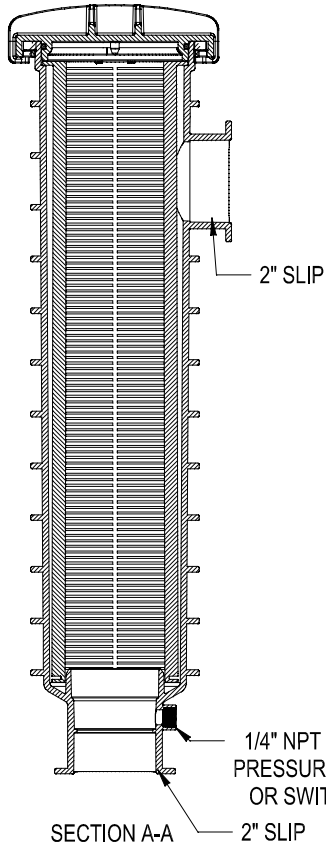

HOUSING LABELING

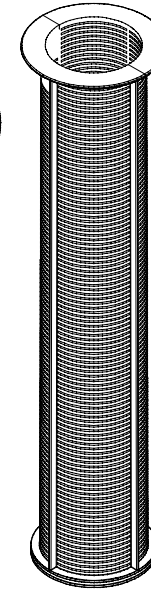
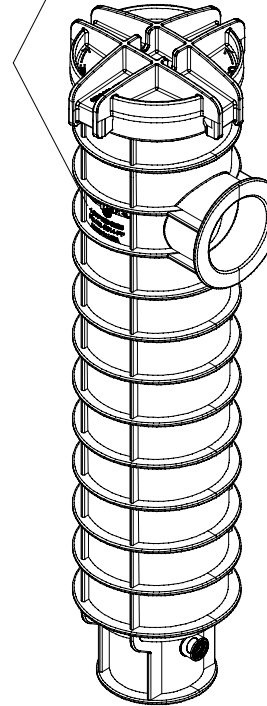

SLOT FILTER
NO. 3014-F

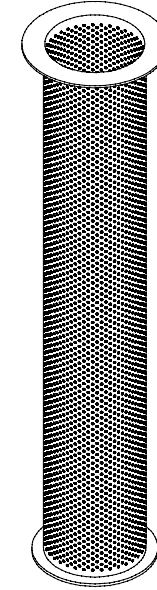

STAINLESS FILTER
NO. 3014-SS

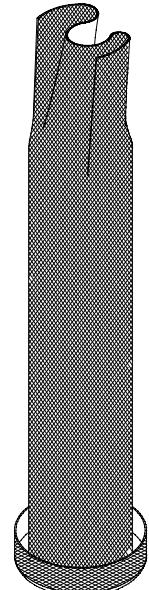

FILTER SOCK
NO. 3014-SOCK

POLYLOK PRESSURE FILTER & HOUSING
PART NO. - 3014-PF

- 1/16" PP SLOT FILTER - 3014-F
- 1/16" STAINLESS STEEL FILTER - 3014-SS
- 100 MICRON FILTER SOCK - 3014 - SOCK